

***RTA International 888-775-1330***

For parts and trouble shooting please go to:

**[www.patioheaterpartsonline.com](http://www.patioheaterpartsonline.com)**

# Assembly Of K/D Wheels

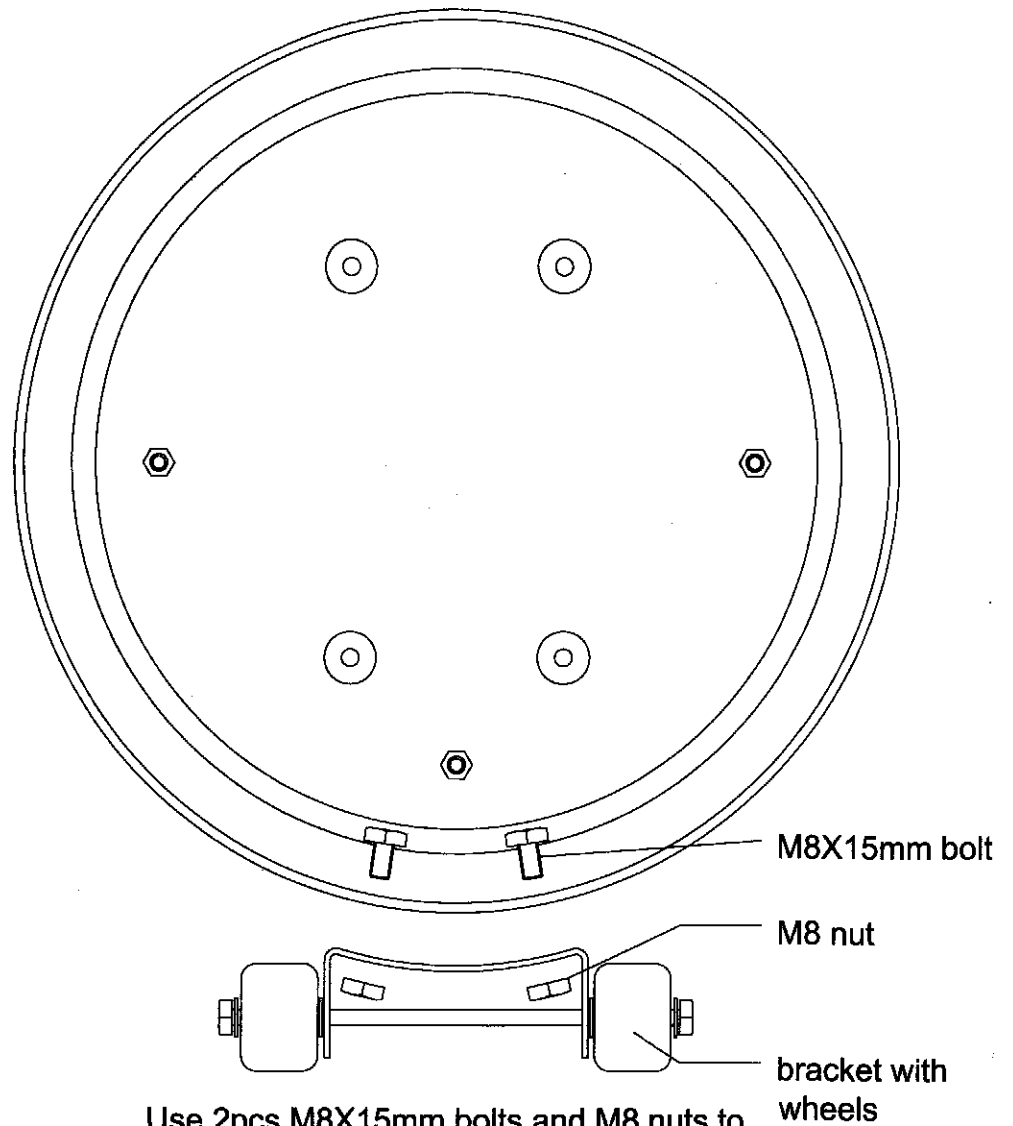

Use 2pcs M8X15mm bolts and M8 nuts to connect the bracket with wheels to the base . Then fasten them.



# PATIO HEATER

## Instruction Manual



# **TABLE OF CONTENTS**

Caution .....	1
Heater Stand and Location .....	2
Gas Requirements .....	2
Leakage Test .....	2
Operation and Storage .....	3
Cleaning and Care .....	4
Parts and Specifications .....	4
Assembly Parts and Procedures .....	6
Problems Check List .....	9

# CAUTION

## PLEASE READ CAREFULLY THE FOLLOWING SAFETY GUIDELINES BEFORE OPERATION.

- Do not use the patio heater for indoors, as it may cause personal injury or property damage.
- This outdoor heater is not intended to be installed on recreational vehicles and/or boats.
- The installation must conform with local codes or, in the absence of local codes, to the National Fuel Gas Code, ANSI Z223. 1-1988, Propane Installation Code.
- Installation and repair should be done by a qualified service person.
- Improper installation, adjustment, alteration can cause personal injury or property damage.
- Do not attempt to alter the unit in any manner.
- Never replace or substitute the regulator with any regulator other than the factory-suggested replacement.
- Do not store or use gasoline or other flammable vapors or liquids in the heater unit.
- The whole gas system, hose, regulator, pilot or burner should be inspected for leaks or damage before use, and at least annually by a qualified service person.
- All leak tests should be done with a soap solution. Never use an open flame to check for leaks.
- Do not use the heater until all connections have been leak tested.
- Turn off the gas valve immediately if smell of gas is detected.
- Do not transport heater while it's operating.
- Do not move the heater after it has been turned off until the temperature has cooled down.
- Keep the ventilation opening of the cylinder enclosure free and clear of debris.
- Do not paint the radiant screen, control panel or top canopy reflector.
- Control compartment, burner and circulation air passageways of the heater must be kept clean. Frequent cleaning may be required as necessary.
- The LP tank should be turned off when the heater is not in use.
- Check the heater immediately if any of the following occurs:
  - the heater does not reach temperature.
  - the burner makes popping noise during use ( a slight noise is normal when the burner is extinguished ).
  - smell of gas in conjunction with extreme yellow tipping of the burner flames.
- The LP regulator/hose assembly must be located out of pathways where people may trip over it or in area where the hose will not be subject to accidental damage.
- Any guard or other protective device removed for servicing the heater must be replaced before operating the heater.
- Adults and children should stay away from high temperature surface to avoid burns or clothing ignition.
- Children should be carefully supervised when they are in the area of the heater.
- Clothing or other flammable materials should not be hung on the heater or placed on or near the heater.

## HEATER STAND AND LOCATION

- The heater is primarily for outdoor use only. Always ensure that adequate fresh air ventilation is provided.
- Always maintain proper clearance to combustible materials, i.e. top 18" and sides 24" minimum.
- Heater must be placed on level firm ground.
- Never operate heater in an explosive atmosphere like in areas where gasoline or other flammable liquids or vapors are stored.
- To protect heater from strong wind, anchor the base securely to the ground with screws.

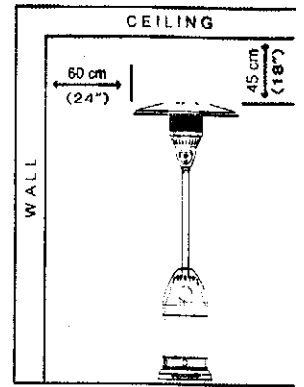

fortification of base to the ground

## GAS REQUIREMENTS

- Use propane or butane gas only.
- The pressure regulator and hose assembly to be used must conform to local standard codes.
- The installation must conform to local codes, or in the absence of local codes, with the standard for the storage and handling of liquid petroleum gases.
- A dented, rusted or damaged propane tank may be hazardous and should be checked by your tank supplier. Never use a propane tank with a damaged valve connection.
- The propane tank must be arranged to provide for vapor withdrawal from the operating cylinder.
- Never connect an unregulated propane tank to the heater.

## LEAKAGE TEST

Gas connections on the heater are leak tested at the factory prior to shipment. A complete gas tightness check must be performed at the installation site due to possible mishandling in shipment or excessive pressure being applied to the heater.

- Make a soap solution of one part liquid detergent and one part water. The soap solution can be applied with a spray bottle, brush or rag. Soap bubbles will appear in case of a leak.
- The heater must be checked with a full cylinder.
- Make sure the safety control valve is in the OFF position.
- Turn the gas supply ON.
- In case of a leak, turn off the gas supply. Tighten any leaking fittings, then turn the gas supply on and re-check.
- Never leak test while smoking.

# OPERATION AND STORAGE

## TO TURN ON THE HEATER

1. Turn on the valve on the gas supply cylinder completely.
2. Press and turn the variable control knob to PILOT position (counter-clockwise 90°).
3. Press down the variable control knob and hold for 30 seconds. While holding down the variable control knob, press the igniter button several times until the pilot flame lights. Release the variable control knob after the pilot flame lights.

Note:

- If a new tank has just been connected, please allow at least one minute for the air in the gas pipeline to purge out through the pilot hole.
  - When lighting the pilot flame make sure that the variable control knob is continuously pressed down while pressing the igniter button. Variable control knob can be released after the pilot flame lights.
  - Pilot flame can be watched and checked from the small round window with sliding lid located at the bottom of the flame screen (to the left or right side of the controller).
  - If the pilot flame does not light or it goes out, repeat step 3.
4. After the pilot flame lights, turn the variable control knob to minimum position and leave it there for 5 minutes or more before turning the knob to desired temperature position.

## TO TURN OFF THE HEATER

1. Turn the variable control knob to PILOT position.
2. Press and turn the variable control knob to OFF position.

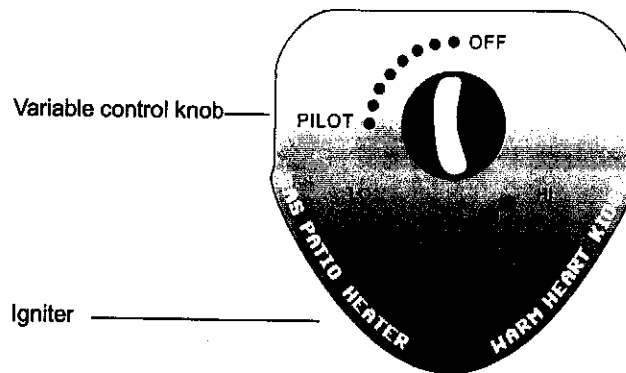

3. Turn off the valve on the gas supply cylinder completely.

## **Storage**

1. Always close the gas valve of the gas cylinder after use or in case of a disturbance.
2. Remove the pressure controller and the hose.
3. Check the tightness of the gas valve and for damage. If you suspect damage, have it changed by your gas dealer.
4. Never store liquid gas cylinder in a sub-terrain, or at places without adequate air ventilation.

## CLEANING AND CARE

- Wipe off powder coated surfaces with soft, moist rag. Do not clean heater with cleaners that are combustible or corrosive.
- Remove debris from the burner to keep it clean and safe for use.
- Cover the burner unit with the optional protective cover when the heater is not in use.

## PARTS AND SPECIFICATIONS

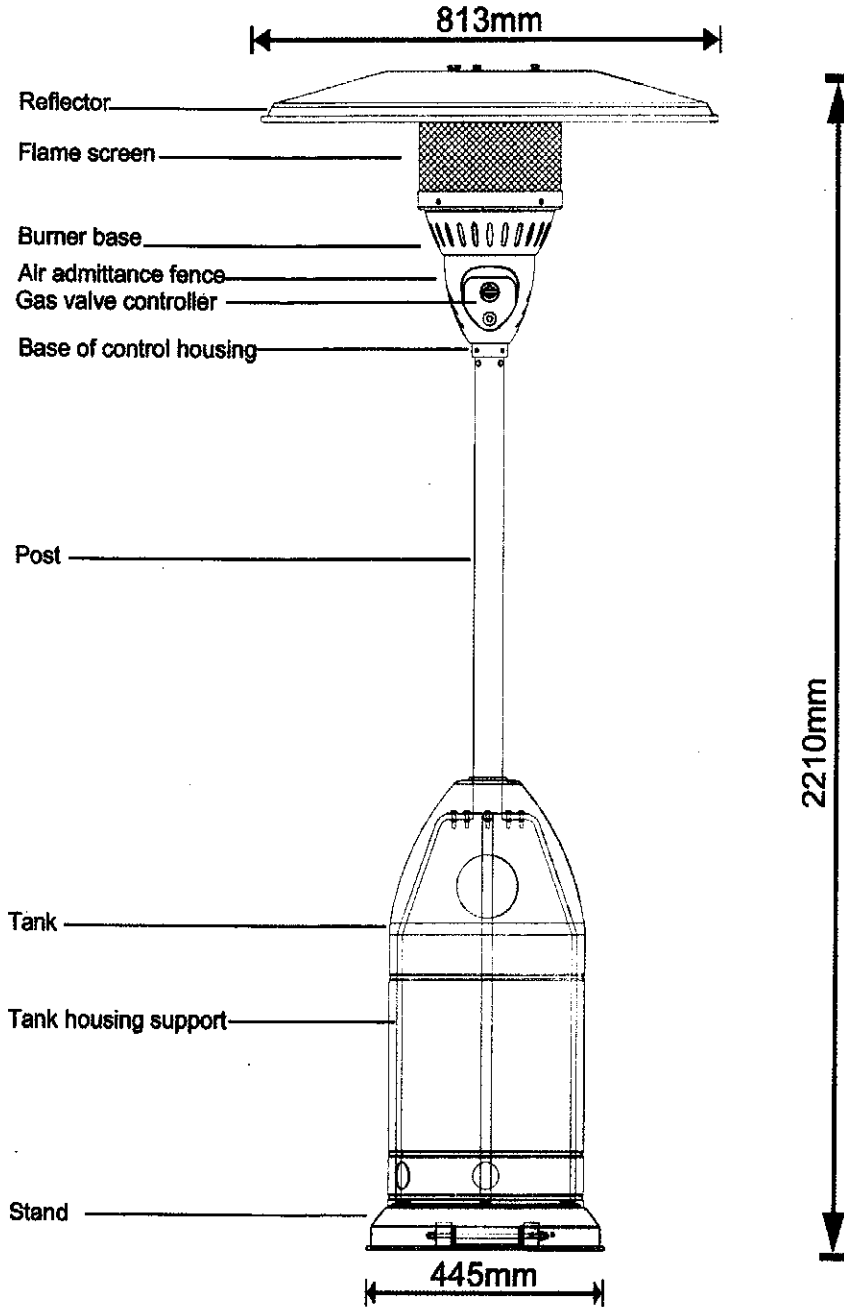



**A. Construction and characteristics**

- Transportable terrace/garden heater with tank housing
- Casing in steel with powder-coating or stainless steel
- Gas hose connections with metal clamp (screw caps for Germany)
- Stainless steel flame screen
- Heat emission from reflector

**B. Specifications**

- For outdoor use only
- Use propane or butane gas only
- Max. wattage: 13000 watts (41000 Btu)
- Min. wattage: 5000 watts (17000 Btu)
- Consumption: 450 g/hr – 870 g/hr
- With CE & CSA certificates

**C. Table of openings**

Gas pressure manifold	Main opening	Opening of pilot burner
280/300 mm H <sub>2</sub> O	1.9 mm	0.20 mm

# ASSEMBLY PARTS

## Tools needed:

- Open end wrench 10 & 13 mm
- Adjustable opening wrench (2) 20 cm long
- Slip joint pliers 23 cm long
- Philips screwdriver w/ medium blade
- Spray bottle of soap solution for leakage test

## Parts supplied:

- Stand with LPG tank housing
- Assembly post with 3 pcs post brackets
- 10 mm x 86 cm (L) galvanized steel pipe
- Reflector 813 mm with 9 pcs Ø8 mm washers, 3 pcs M8 castle nut and 3 pcs M8 burner/reflector support bolt
- 4 pcs bolts M6 x 10 mm for assembly post and burner
- 6 pcs bolts & nuts M6 x 35 mm for post and post brackets
- 3 pcs bolts M8 x 16 mm for post brackets and stand
- 3 pcs ground fixer
- 6 pcs M6 x 10 mm ground fixer bolts & nuts

## ASSEMBLY PROCEDURES

### STEP 1

- 1-1. Put the 3 pcs post brackets on each position on the base as shown in the picture.
- 1-2. Use 3 pcs M8 x 16 mm bolts to join the post brackets and stand.

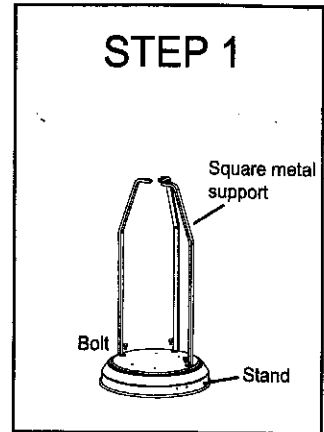

### STEP 2

- 2-1. Put the post on the top of 3 pcs post brackets.
- 2-2. Use 6 pcs M6 x 35 mm bolts and nuts to connect the post to the 3 pcs post brackets. Tighten the bolts and nuts.

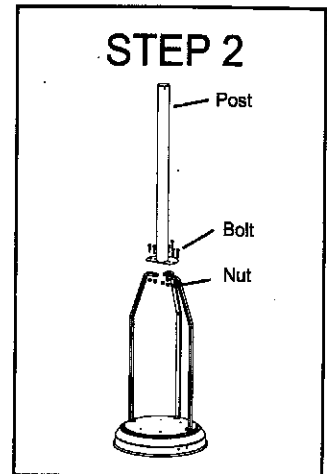

### STEP 3

- Place the tank housing on the stand.

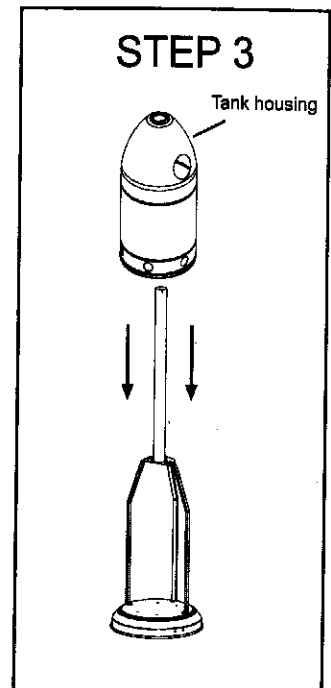

#### STEP 4

- 4-1. Fit the gas hose/pipe nut to the burner gas inlet connector.
- 4-2. Tighten the gas hose/pipe nut and gas inlet thread.
- 4-3. Fix the completed burner unit to the post by 4 pcs M6 x 10 mm bolts.

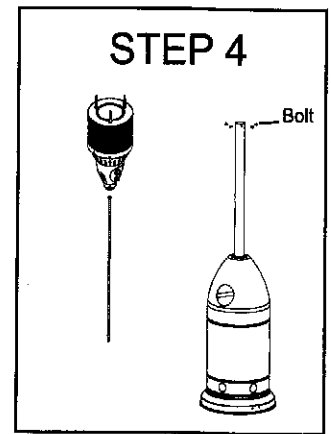

#### STEP 5

- 5-1. Check whether the connection of vertical post and burner are assembled according to instructions, and all bolts and nuts are tightened.
- 5-2. Put washer Ø8 mm on each reflector support bolt.

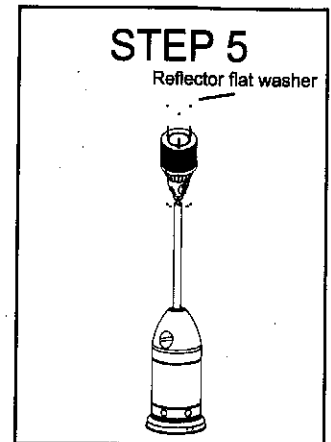

#### STEP 6

- 6-1. Fasten the reflector with 3 pcs washers and 3 pcs M8 mm dome nuts.

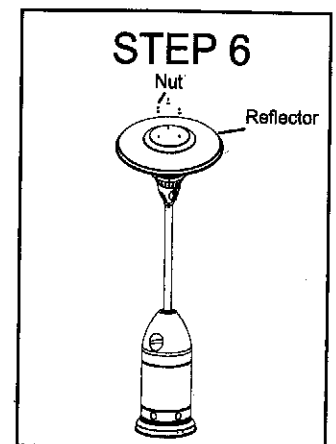

### STEP 7

- 7-1. Bring up the tank housing and rest it on the post plate.
- 7-2. Connect the regulator to the gas tank and tighten it with adjustable wrench.
- 7-3. Connect the end thread of inlet gas hose to the regulator.
- 7-4. Put LPG gas tank on the stand.

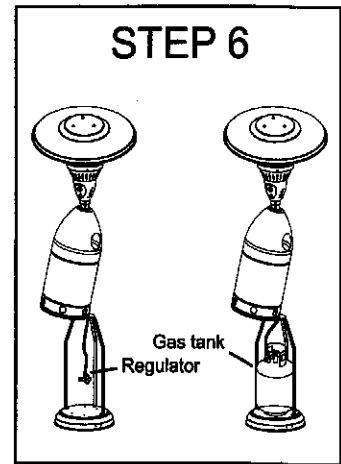

## PROBLEMS CHECK LIST

<u>PROBLEM</u>	<u>PROBABLE CAUSE</u>	<u>SOLUTION</u>
Pilot will not light	Gas valve may be OFF Tank fuel empty Opening blocked Air in supply system Loose connections	Turn the gas valve ON Refill LPG tank Clean or replace opening Purge air from lines Check all fittings
Pilot will not stay on	Debris around pilot Loose connections Thermocouple bad Gas leak in line Lack of fuel pressure	Clean dirty area Tighten connections Replace thermocouple Check connections Tank near empty. Refill LPG tank.
Burner will not light	Pressure is low Opening blocked Control not ON Thermocouple bad Pilot light assembly bent Not in correct location	Tank near empty. Refill LPG tank. Remove and clean Turn valve to ON Replace thermocouple Place pilot properly Position properly and retry